

# ELECTRIC FLAT PANEL FIREPLACE HEATER

Model# : 80006

## OWNER'S MANUAL

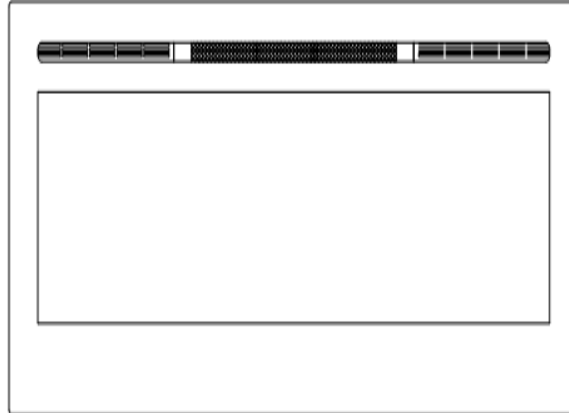

40" Wall Mounted / Built-in  
Electric Fireplace

**AC 120V 60Hz 1500W**

### **WARNING**

**Read and understand** this entire owner's manual, including **all safety information**, before **plugging in** or **using** this product. Failure to do so could result in **fire, electric shock, or serious personal injury**.

### **CAUTION**

**Keep this owner's manual** for future reference. If you sell or give this product away, **make sure this manual accompanies this product**.



**PREMIUM  
ELECTRIC FIREPLACES  
& TV LIFTS**

Exceeding Expectations





# IMPORTANT SAFETY INFORMATION!

## WARNING

- **Read all instructions before using this heater!**
- This heater is **hot when in use**. To avoid burns, **DO NOT** let bare skin touch **hot** surfaces. If provided, use handles when moving this heater. Keep **combustible materials**, such as furniture, pillows, bedding, papers, clothes, and curtains at least **3 feet (0.9m)** from the **front of the heater**, and **keep them away from the sides and rear**.
- **Extreme caution** is necessary when any heater is used by or near **children** or **invalids** and whenever the heater is left **operating and unattended**.
- **DO NOT** operate any heater with a **damaged cord or plug** or after the **heater malfunctions**, has been **dropped** or **damaged in any manner**. Discard heater, or return to authorized service facility for examination and/or repair.
- **DO NOT** run **power cord** under carpeting. **DO NOT** cover power cord with throw rugs, runners, or similar coverings. **DO NOT** route power cord under furniture or appliances. Arrange power cord **away from traffic** area, and where it will not be tripped over.
- **Connect to properly grounded outlets ONLY.**
- **DO NOT** insert or allow **foreign objects** to enter any **ventilation or exhaust opening**, as this may cause **electric shock** or **fire**, or **damage the heater**.
- To prevent a possible fire, **DO NOT** block air intakes or exhaust in any manner. Doing so could cause a **fire**. **DO NOT** use on soft surfaces, like a bed, where openings may become blocked.
- A heater has **hot and arcing or sparking parts inside**. **DO NOT** use it in areas where **gasoline, paint, or flammable liquids** are used or stored.
- **Use this heater only as described in this manual. Any other use not recommended by the manufacturer may cause fire, electric shock, or injury to persons.**
- **ALWAYS** plug heaters directly into a wall outlet/receptacle. **NEVER** use with an extension cord or relocatable power tap (outlet/power strip).
- **DO NOT** place the heater near a bed because objects such as pillows or blankets can fall off the bed and be ignited by the heater.
- **NEVER** use this heater in **bathrooms, laundry rooms**, or any other location where the heater could fall into a **bathtub** or **pool, become damp, or come in contact with water**.
- **AVOID FIRE!** Regularly inspect all air vents to make sure they are free from dust, lint, or other blockage. **Unplug the unit** and clean with a **vacuum ONLY**. **DO NOT** rinse or get wet.
- **ALWAYS** mount to wall bracket before use. **DO NOT** set on the floor, or other surface, to use.
- **NEVER** use a wall mount bracket from another manufacturer.
- This product is **not intended** to be a **primary heat source**. It is for **supplemental heat only**.
- **INDOOR use only! NEVER** use this heater **outdoors!** Doing so may result in **electric shock!**
- **Risk of electric shock! DO NOT OPEN!** No user-serviceable parts inside!

- **ALWAYS** turn this heater off before unplugging it from the outlet.
- **ALWAYS disconnect** this unit from the **power** supply **before** performing any assembly or cleaning, or before relocating the electric fireplace.
- **NEVER** leave this heater unattended. **ALWAYS** unplug this heater when not in use.
- **ALWAYS** store this heater in a dry location. **NEVER** use the fireplace if it has become wet.
- **NEVER** plug this heater into an outlet that is **old, cracked,** or has any **loose wires or connections.** Plugging this heater into a faulty outlet could result in **electric arcing** within the outlet that could cause the **outlet to overheat or catch fire.**
- **ALWAYS** check your heater cord and plug connections with **each use!**
  - i) **MAKE SURE** the plug fits tight in the outlet! Faulty wall outlet connections or loose plugs can cause the outlet to overheat.
  - ii) **Heaters draw more current** than small appliances. **Overheating** may occur even if it has not occurred with the use of other appliances.
  - iii) During use **check frequently** to see if the **plug outlet or face plate is HOT!**
  - iv) If the outlet or face plate is **HOT, discontinue use immediately** and have a qualified electrician inspect and/or replace the faulty outlets.
- The power cord supplied with the heater has three prongs: two flat blades (live and neutral) and one round pin (ground). If a 3-slot receptacle is not available, an adapter **MUST** be used. The adapter **MUST** be **properly grounded** to the outlet box (see figure at right). [NOTE: Adapter NOT INCLUDED.]
- **SAVE THESE INSTRUCTIONS!**

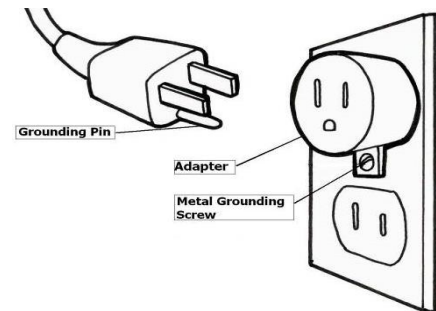

## Preparation











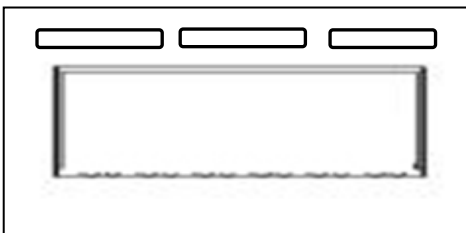

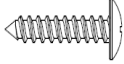
This product includes a **GLASS panel!** Always use **extreme caution** when handling **glass.** Failure to do so could result in **personal injury** or **property damage.**

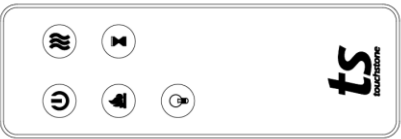
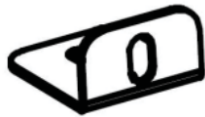
Remove all parts and hardware from the carton and place them on a clean, soft, dry surface. Parts and assembly steps are grouped for wall-hanging or recessing use. Check the parts list to make sure nothing is missing. Dispose of packaging materials properly. Please recycle whenever possible.

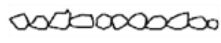
**You will need the following tools (not included):** Phillips screwdriver; stud finder; level; tape measure; electric drill; 1/4" wood drill bit, hammer.

# Parts and Hardware

 <p><b>A – Fireplace</b></p>				
	<p><b>B – Wood Screws</b></p>		<p><b>C – Drywall anchors</b></p>	
				
				
<p><b>E - Wall Bracket</b> Fixed on back of firebox</p>	<p><b>F-Decorative Pebbles</b> <input checked="" type="checkbox"/></p>	<p><b>G-Decorative Crystals</b> <input checked="" type="checkbox"/></p>	<p><b>H - Log set</b> <input checked="" type="checkbox"/></p>	<p><b>I - Plastic Tray</b> <input checked="" type="checkbox"/></p>

# Specification and Dimension

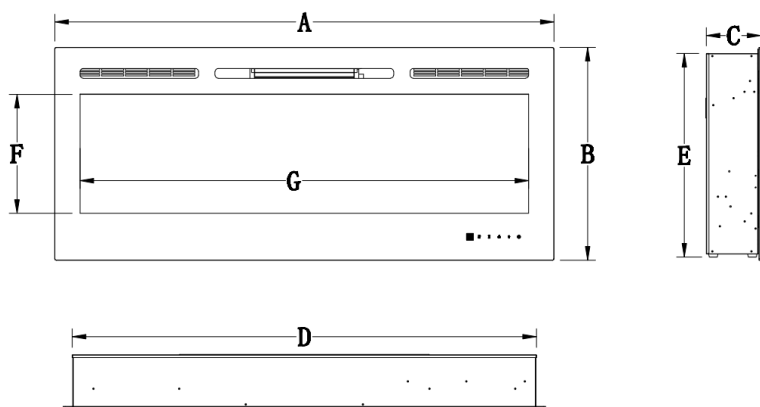

Description	Electric Fireplace
Type	3 Way Mounting Unit Wall-Mount, Recess into Wall and Assemble with mantel
Voltage	120V AC
Watts	MAX 1500W
Amps	15 AMP Grounded Circuit

## PRODUCT DIMENSIONS

Model Number	A	B	C	D	E	F	G
80006	40" 101.6cm	26.53" 67.4cm	5.51" 14cm	32.48" 82.5cm	25.63" 65.1cm	17.12" 43.5cm	30.9" 78.5cm

# Installation and Assembly

Your appliance is a wall-mounted, recessed and/or mantel installed appliance. Select a suitable location that is not susceptible to moisture and is away from drapes, furniture and high traffic areas.

**NOTE: Follow all National and local electrical codes.**

## MINIMUM CLEARANCE TO COMBUSTIBLES

Measurements are taken from the glass front.			
Bottom	0"	Top	8" to mantel
Sides	0"	Top	8" to ceiling
Back	0"		

## MINIMUM MANTEL CLEARANCES

### WARNING

WHEN USING PAINT OR LACQUER TO FINISH THE MANTEL, THE PAINT OR LACQUER MUST BE HEAT RESISTANT TO PREVENT DISCOLOURATION.

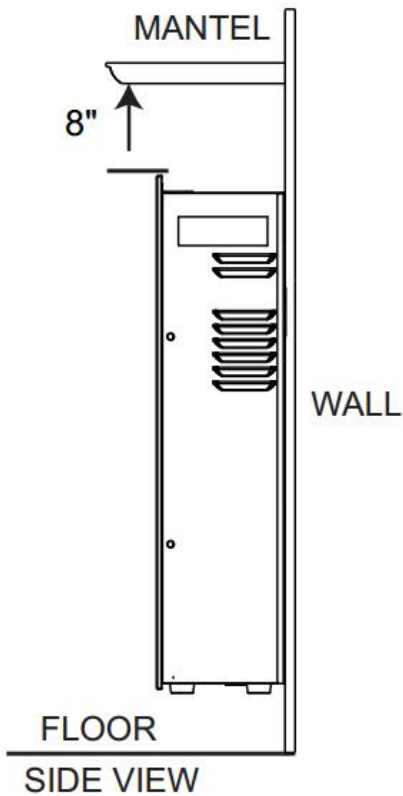

# RECESSED TO WALL INSTALLATION

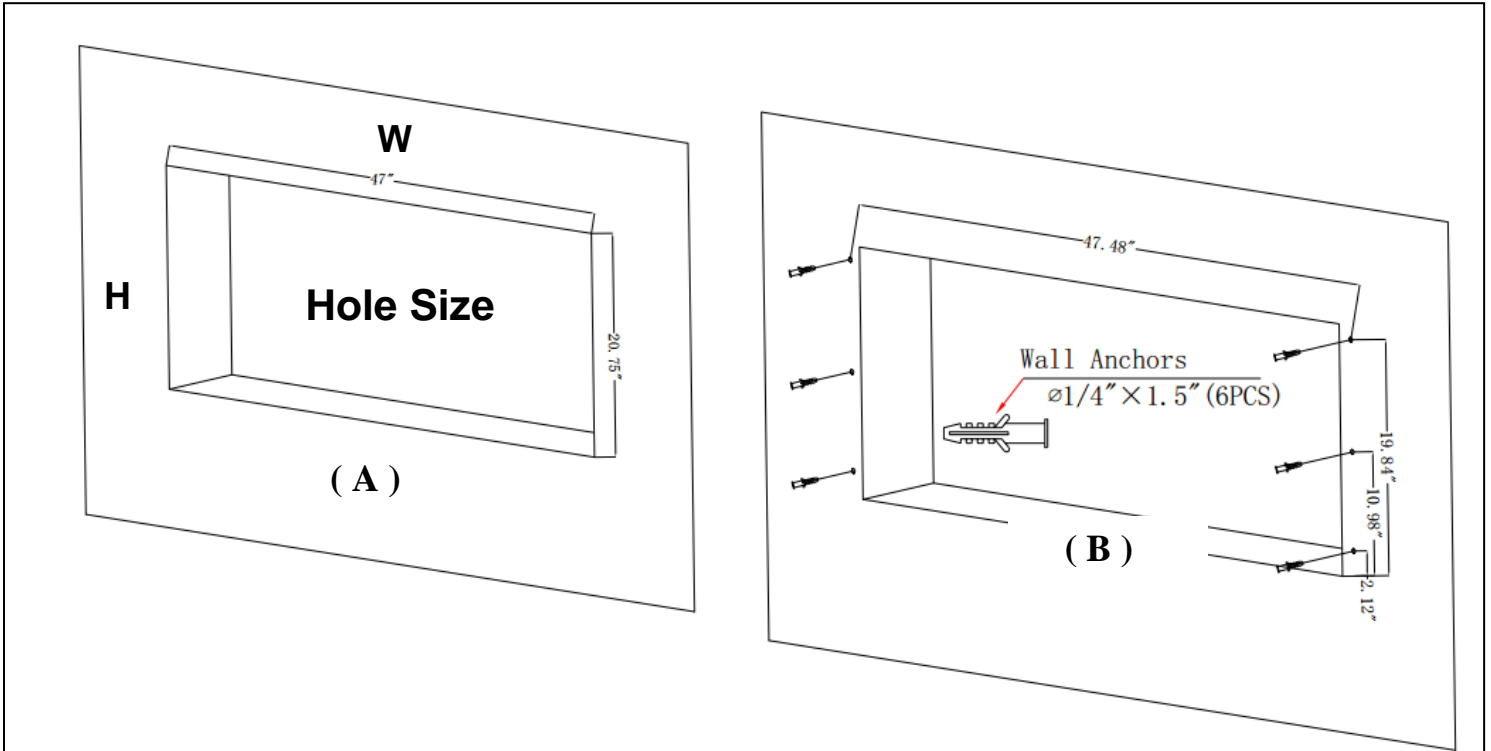

**STEP A.** Selection a dry wall to open a hole for fireplace box. Size or note as below chart **Figure ( A )**

Framing Hole Size		
Model Number	W	H
80006	33" (83.82CM)	26.02(66.1CM)

**STEP B.** Fix the three wall anchors in each side of the fireplace box according to the dimensions showed on the drawing. **Figure (B)**

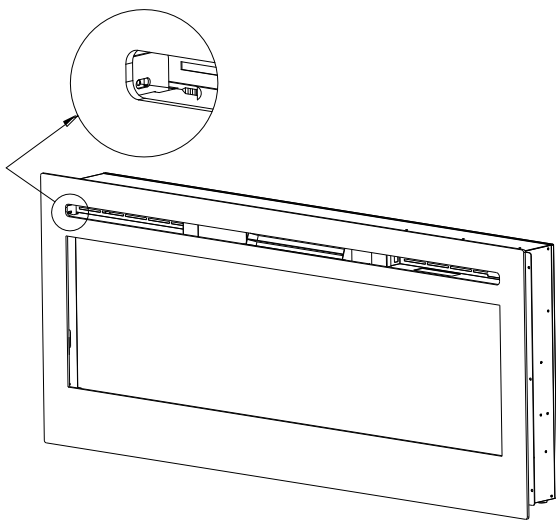

( C )

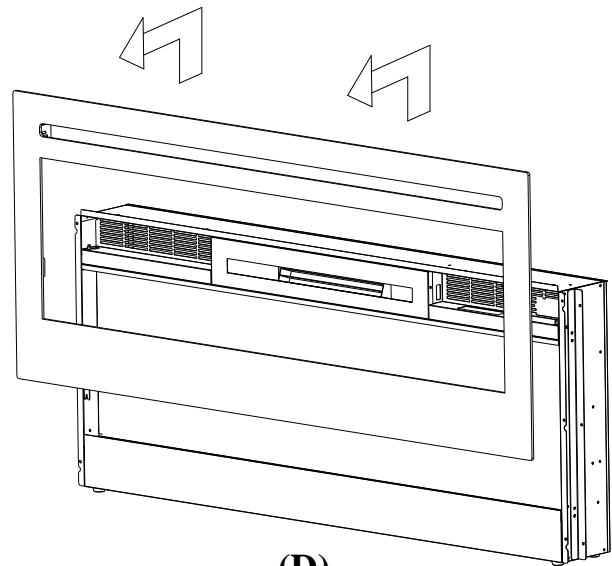

( D )

**STEP C.** Take off the two screws in both sides of the glass panel. **Figure ( C )**

**STEP D.** Have two person to take the glass panel out of the fireplace box. Place it to a soft and clean place. **Figure ( D )**

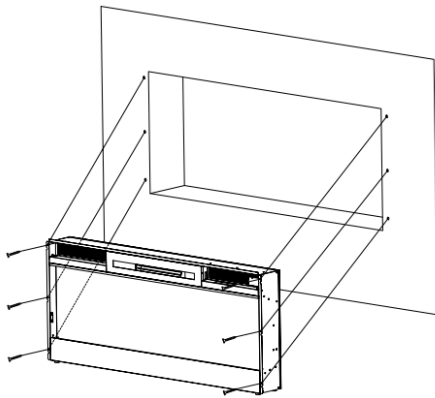

( E )

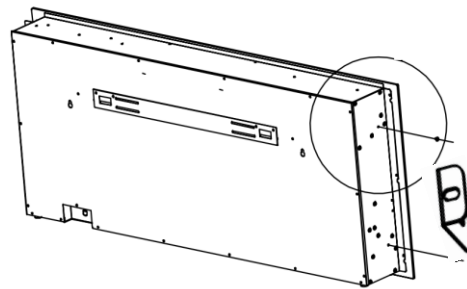

( F )

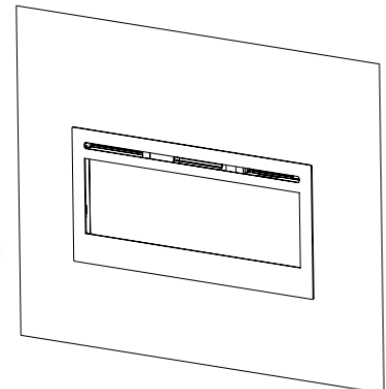

( G )

**STEP E.** Have two person to move the fireplace box to the wall hole.

**If the appliance is fully recessed into the wall:**

- Use the 6 screws (provided) to lock the appliance into the wall with the existing two side flanges, see **Figure ( E )**
- Install the media and re-install the glass front.

**If partial recess into the wall:**

- Use the four mounting metal brackets (supplied) to lock the appliance to the wall, see **Figure ( F )**

**NOTE: Using the existing holes on sides of the appliance for recessing into wall.**

**STEP F.** Fireplace will be like this after installation **Figure ( G )**



# Wall Mounted Installation

Due to the many different materials used on different walls, it is highly recommended that you consult your local builder before you install this appliance on the wall.

**A.** Select a location that is not prone to moisture and is located at least 36" (914mm) away from combustible materials such as curtain drapes, furniture, bedding, paper, etc.

**B.** Have two people hold the appliance against the wall to determine the final location.

**C.** Place unit face down on a soft, non abrasive surface. Remove the bracket from the back of the unit by removing the screws, refer to Figure 1.

**D.** Mark out location, then mount the bracket(s) onto the wall using the supplied screws. This bracket

MUST have the hooks facing upward and be level. **NOTE: It is strongly**

**recommended that the mounting bracket (E) be Screwed into the wall studs Where possible. If the wall Studs cannot be used, ensure**

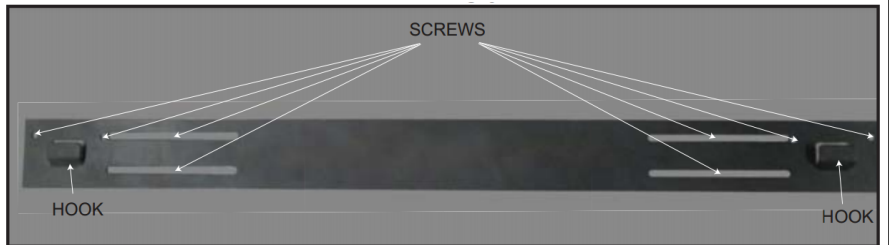

**That the supplied plastic anchors are used to affix the bracket to the wall and the bracket is adequately secured.**

**E.** With the wall mounting bracket installed have two people lift the appliance up and insert the two hooks on the bracket into the two slots on the back of the appliance.

**F.** Check the appliance for stability ensuring that the bracket will not pull free from the wall.

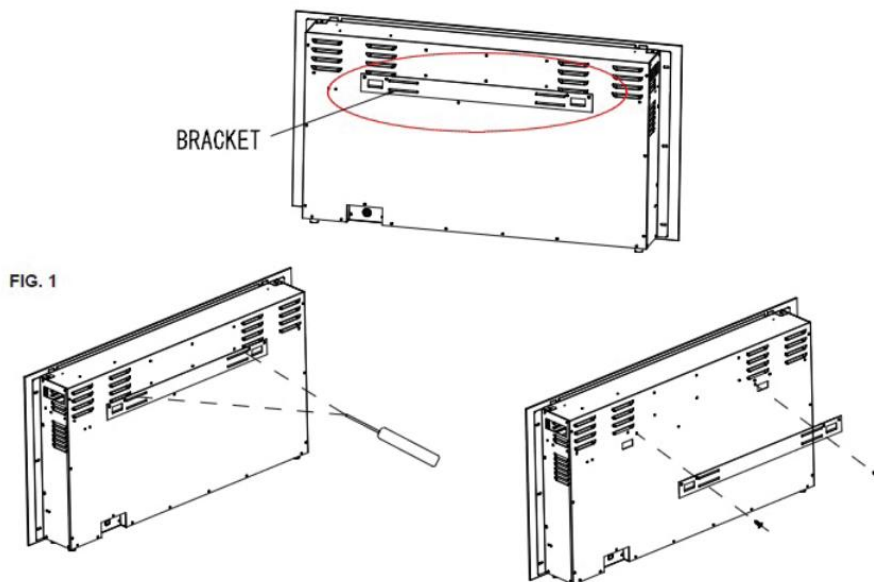

80006 Wall Bracket Illustrated

# WARNING

TURN OFF THE APPLIANCE COMPLETELY AND LET COOL BEFORE SERVICING. ONLY A QUALIFIED SERVICE PERSON SHOULD SERVICE AND REPAIR THIS ELECTRIC APPLIANCE.

## HARD WIRING CONNECTION

If it is necessary to hard wire this appliance, a qualified electrician must remove the cord connection, and wire the appliance directly to the house hold wiring.

This appliance must be electrically connected and grounded in accordance with local codes, if hard wired. In the absence of local codes, use the current CSA C22.1 CANADIAN ELECTRICAL CODE in Canada or the current ANSI/NFPA 70 NATIONAL ELECTRICAL CODE in the United States.

Fig. 1

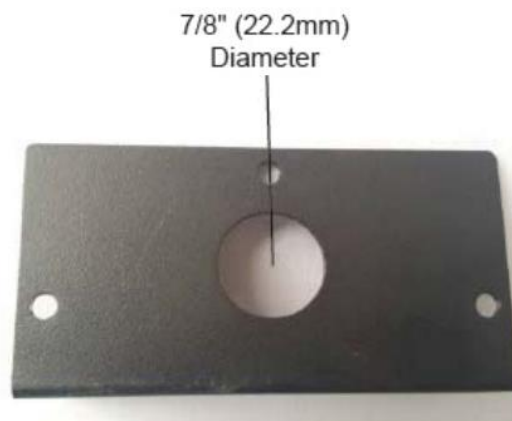
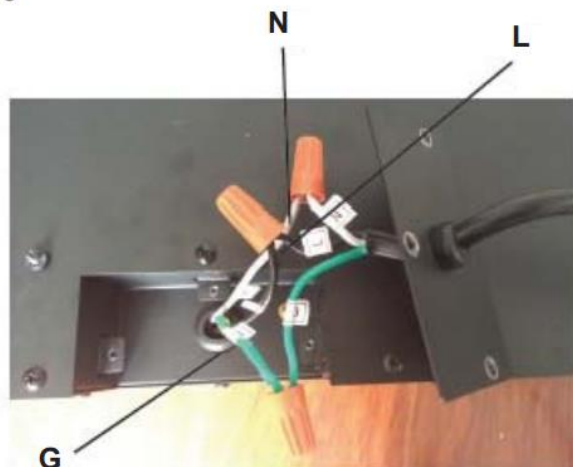

Fig. 2



- A. Remove the cover plate from the right side bottom of the appliance by removing the three screws, as shown above.
- B. Remove the wire connectors from the power cord. The power cord may be discarded.
- C. Take the new cover plate, supplied in the hardware bag. Punch out the 7/8" (22.2mm) hole and install a box connector through, into the junction box. Snap the box connector clamp onto the supply wires.
- D. Using the wire connectors, connect the ground green wires (G), the common white wires (N) together, then the hot black wires (L) and then the refer to Figure 3.
- E. Reinstall the cover plate using the three screws, as shown in Figure 1.

Fig. 3



# Logset / Crystal / Pebble Ember Installation

(NOTE: Please make the installation according to the embers which you bought or selected.)

- A. Glass front must be removed and the appliance must be mounted in its final location before the logset / crystal / pebble embers are installed.
- B. If your fireplace come with logset, remove the logset from the package, put it to the fireplace designed place. **Figure 1.**
- C. **CLEAN CRYSTAL or PEBBLE MEDIA:** Crystal or pebbles media may have a fine oil residue that needs to be cleaned prior to installation. Clean the them with mild dish soap, drain, rinse thoroughly and dry before placing into the tray.
- D. Place the plastic tray ( I ) to the fireplace designed place. Then carefully place crystal or pebbles embers into the bottom tray on the front of the appliance as illustrated. Apply an even layer from side to side. **Figure 2, Figure 3.**

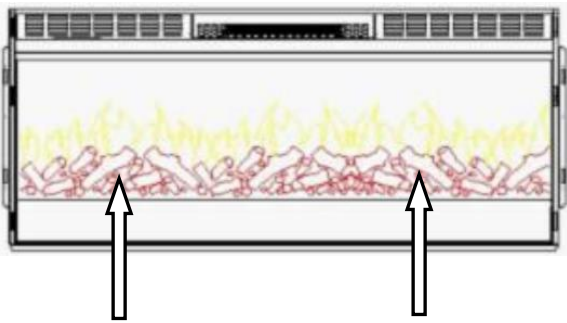

**Figure 1.**

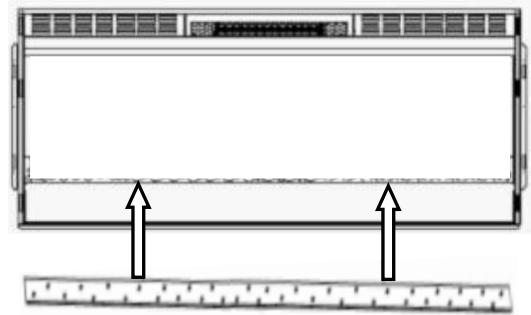

**Figure 2.**



**Figure 3. (Crystal medias)**



**Figure 3. (Pebbles medias)**

## Operation



**Read and understand** this entire owner's manual, including **all safety information**, before plugging in or **using** this product. Failure to do so could result in **electric shock, fire, serious injury, or death.**

## Power

Plug the power cord into a 110~120 Volt 15 Amp grounded outlet (see **IMPORTANT SAFETY INFORMATION** on **Pages 2 and 3**). Make sure the outlet is in good condition and that the plug is not loose. **NEVER** exceed the maximum amperage for the circuit. **DO NOT** plug other appliances into the same circuit.

## Methods of Operation

This electric fireplace can be operated by the CONTROL PANEL, located on the UP right side glass panel slot of the fireplace, or by the battery-powered REMOTE CONTROL.

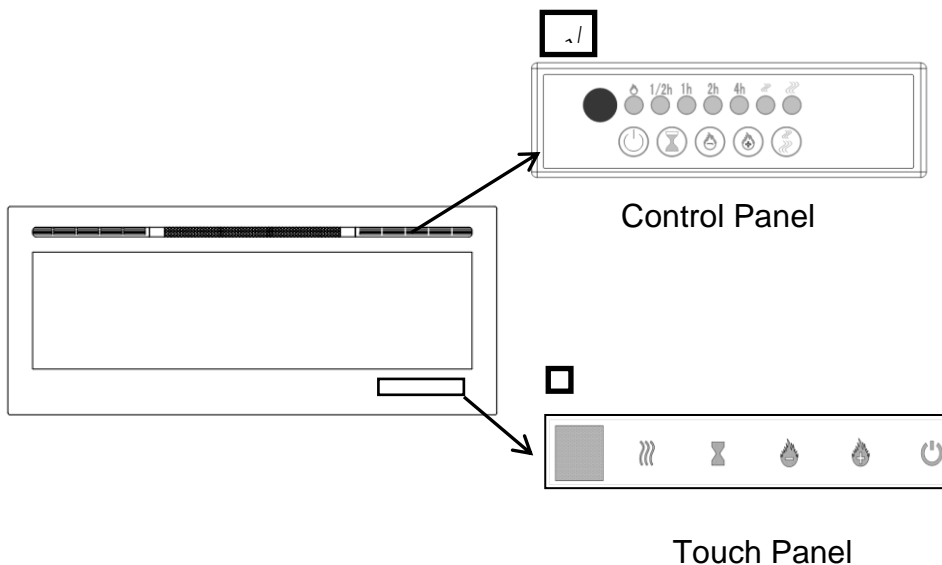

The operation and functions of the two methods are the same.

Before operating, please review the **IMPORTANT SAFETY INFORMATION** on **Pages 2 and 3**, and heed all warnings.



## Control Panel / Touch Panel / Remote Control Operation

BUTTON	FUNCTION	ACTION & INDICATION
 <b>POWER</b>	<b>ON:</b> Enables control panel functions and remote control. Turns on flame effect. <b>OFF:</b> Disables control panel functions and remote control. Turns off flame effect.	1. <b>Press once.</b> Indicator light turns on. Power turns on. All functions enabled. 2. <b>Press again.</b> Flame effect turns off. Power and all functions turn off.
 <b>TIMER</b>	<b>TIMER button:</b> Controls timer settings to turn off fireplace at selected time. Settings range from 0.5 hours to 7.5 hours.	1. <b>Press once.</b> Indicator light turns on. Timer is set to 0.5 hours. 2. <b>Press again until desired setting is reached.</b> Indicator lights show setting.

 <b>FLAME</b>	<p><b>FLAME button:</b> Makes flame effect dimmer and brighter.</p> <p><b>NOTE:</b> Flame effect stays on until power button is turned off. Flame effect must be on for heater to turn on.</p>	<ol style="list-style-type: none"> <li>1. <b>Press once.</b> Flame brightness effect gets changing.</li> <li>2. <b>Press again.</b> until desired setting is reached.</li> </ol>
 <b>COLOR</b>	<p><b>COLOR button:</b> Makes the color flame effect changing.</p> <p><b>NOTE:</b> color effect stays on until power button is turned off. Color flame effect must be on for heater to turn on.</p>	<ol style="list-style-type: none"> <li>1. <b>Press once.</b> Flame color effect gets changing.</li> <li>2. Press again until desired setting is reached.</li> </ol>
 <b>HEATER</b>	<p><b>HEATER button:</b> Turns heater on and off.</p> <p><b>NOTE:</b> The heater only works when the flame effect is on. If the flame effect is off, the heater will not turn on.</p> <p><b>NOTE:</b> To prevent overheating, the heater blows cool air for 10 seconds before the heater turns on, and after it turns off.</p>	<ol style="list-style-type: none"> <li>1. <b>Press once.</b> Indicator lights up. Fan blows cool air for 10 seconds. Low heater turns on and blows warm air.</li> <li>2. <b>Press again.</b> Indicator lights up. High heater turns on and blows hot air.</li> <li>3. <b>Press again.</b> Heaters turn off. The fan blows cool air, then turns off.</li> </ol>

**NOTICE** When the heater is first turned on, a slight odor may be present. This is normal and should not occur again unless the heater is not used for a long period of time.

**NOTICE** To improve operation, **aim** the remote control at the front of the fireplace. **DO NOT press the buttons too quickly.** Give the unit time to respond to each command.

## Temperature Limiting Control

This heater is equipped with a Temperature Limiting Control. Should the heater reach an unsafe temperature, the heater will automatically turn OFF. To reset:

1. Unplug the power cord from the outlet.
2. Turn the ON/OFF switch on the CONTROL PANEL to OFF. **Wait 5 minutes.**
3. Inspect the fireplace to make sure no vents are blocked, or clogged with dust or lint. If they are, use a vacuum to clean the vent areas.
4. With the POWER switch in the OFF position, plug the power cord back into the outlet.
5. If the problem continues, have your outlet and wiring inspected by a professional.

## Remote Control Battery Information

- Remote control uses **CR2025** batteries (**Included**)

 **NEVER** dispose of batteries in **fire**. Failure to observe this precaution **may result in an explosion**. Dispose of batteries at your local hazardous material processing center.

# Care and Maintenance

## Cleaning



**ALWAYS** turn the heater **OFF** and **unplug the power cord from the outlet** before cleaning, performing maintenance, or moving this fireplace. Failure to do so could result in **electric shock, fire, or personal injury**.



**NEVER** immerse in water or **spray with water**. Doing so could result in **electric shock, fire, or personal injury**.

### Metal:

- Buff using a soft cloth, slightly dampened with a citrus oil-based product.
- **DO NOT** use brass polish or household cleaners as these products will damage the metal trim.

### Glass:

- Use a good quality glass cleaner sprayed onto the cloth or towel. Dry thoroughly with a paper towel or lint-free cloth.
- **NEVER** use abrasive cleansers, liquid sprays, or any cleaner that could scratch the surface.

### Vents:

- Use a vacuum or duster to remove dust and dirt from the heater and vent areas.

### Plastic:

- Wipe gently with a slightly damp cloth and a mild solution of dish soap and warm water.
- **NEVER** use abrasive cleansers, liquid sprays, or any cleaner that could scratch the surface.

## Maintenance



**Risk of electric shock! DO NOT OPEN any panels ! No user-serviceable parts inside!**



**ALWAYS** turn the heater **OFF** and **unplug the power cord from the outlet** before cleaning, performing maintenance, or moving this fireplace. Failure to do so could result in **electric shock, fire, or personal injury**.

### Electrical and Moving Parts:

- The fan motors are lubricated at the factory and will not require lubrication.
- Electrical components are integrated in the fireplace and are not serviceable by the consumer.

### Storage:

- Store heater in a clean dry place when not in use.



**WARNING! NO SERVICING** of the internal or electrical parts should be performed by the consumer. Do not service the unit yourself.





**CALL US FIRST!**



**DO NOT RETURN TO STORE.**

For immediate help with assembly, product information,  
or if your product arrives damaged, call our toll-free number at

**800-215-1990**

or email:

[customerservice@thpus.com](mailto:customerservice@thpus.com)

**Our staff is ready to provide assistance.**